

# DONUT

Thanks for choosing our DONUT LED oyster products.  
We strongly recommend that you read this manual carefully before installation.

## Product Specifications

PRODUCT CODE	POWER	CCT	LUMEN	NET WEIGHT
DONUT25W	25W	3000K/4000K	2200lm	1.30kg

## Installation Instructions

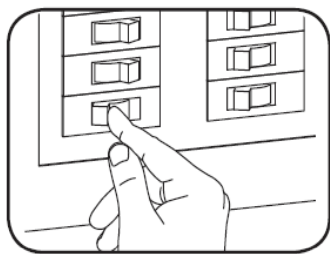

1. Switch OFF main power supply

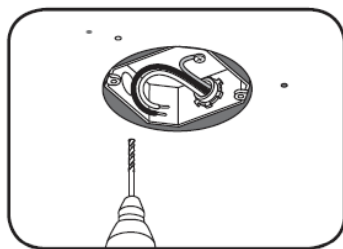

2. Mark and drill holes in mounting surface and install plug anchors.

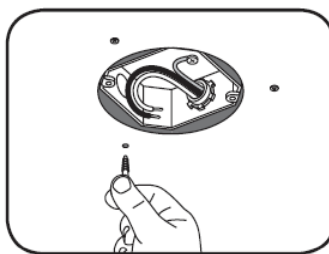

3. Remove front cover. Secure luminaire on to the ceiling.

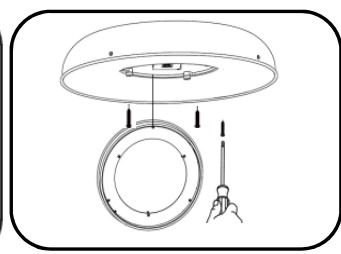

4. Wire the luminaire in accordance with marked terminals.

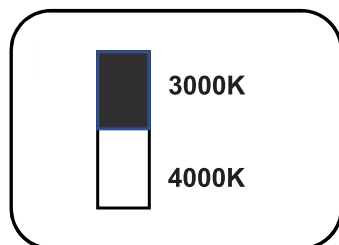

5. Set desired colour temperature.

For motion sensor dip switch, refer to Intellisensor section of this installation guide.

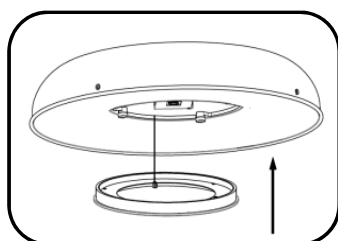

6. Reattach the cover. Push in to ensure fully secured.

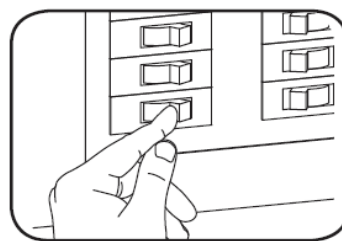

7. Switch ON main power

Product Code: **DONUT25W-BK**  
**DONUT25W-WH**  
**DONUT25W-BK-MS**  
**DONUT25W-WH-MS**

# DONUT

## Intellisensor dipswitch settings

NOTE: This section only applies to the below models:

- **DONUT25W-BK-MS**
- **DONUT25W-WH-MS**

### Features:

- Integrated daylight and motion sensor
- 180° detection range
- 5m detection range

### Settings:

Detection Range		Hold Time		Daylight Sensor		Standby Period		Standby Dimming level	
1		2	3	4		5	6	7	8
<input type="checkbox"/>	100%	<input type="checkbox"/>	<input type="checkbox"/>	<input type="checkbox"/>	Disable	<input type="checkbox"/>	<input type="checkbox"/>	<input type="checkbox"/>	<input type="checkbox"/>
<input type="checkbox"/>	50%	<input type="checkbox"/>	<input type="checkbox"/>	<input type="checkbox"/>	50Lux	<input type="checkbox"/>	<input type="checkbox"/>	<input type="checkbox"/>	<input type="checkbox"/>
		<input type="checkbox"/>	<input type="checkbox"/>			<input type="checkbox"/>	<input type="checkbox"/>	<input type="checkbox"/>	<input type="checkbox"/>
		<input type="checkbox"/>	<input type="checkbox"/>			<input type="checkbox"/>	<input type="checkbox"/>	<input type="checkbox"/>	<input type="checkbox"/>
		<input type="checkbox"/>	<input type="checkbox"/>			<input type="checkbox"/>	<input type="checkbox"/>	<input type="checkbox"/>	<input type="checkbox"/>
		<input type="checkbox"/>	<input type="checkbox"/>			<input type="checkbox"/>	<input type="checkbox"/>	<input type="checkbox"/>	<input type="checkbox"/>
		<input type="checkbox"/>	<input type="checkbox"/>			<input type="checkbox"/>	<input type="checkbox"/>	<input type="checkbox"/>	<input type="checkbox"/>
		<input type="checkbox"/>	<input type="checkbox"/>			<input type="checkbox"/>	<input type="checkbox"/>	<input type="checkbox"/>	<input type="checkbox"/>

### Dimensions:

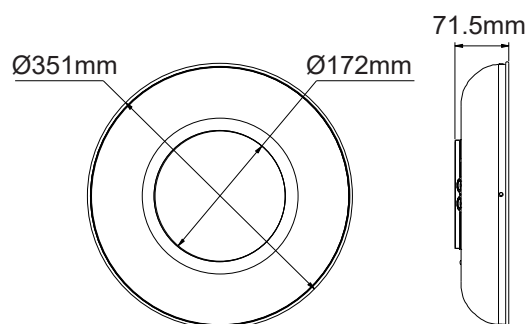

### **WARNING**

- The luminaire must be installed by professional electrician.
- Switch power off when wiring the luminaire.
- Ensure input voltage conforms to the voltage range of product.
- Ensure wires are securely connected.
- Before switching on, ensure that all the wiring is correct.
- The warranty is void if product is not installed according to the instructions.

Product Code: **DONUT25W-BK**  
**DONUT25W-WH**  
**DONUT25W-BK-MS**  
**DONUT25W-WH-MS**