



DESCRIPTION

The ProVent Series of in-line mixed-flow fans have been specifically designed for ducted supply or exhaust air applications.

There are 6 models in the range matching standard duct sizes from 100 to 200mm diameter.

Typical Applications

From warm and cool air transfer, to the ventilation of toilets, laundries, ensuites, wine-cellars and kitchens in homes, apartments, hotels and commercial premises. Suitable for both supply and exhaust air applications.

Features

- High performance mixed-flow Impeller.
- Models 150SW and 200SW include an external mounted 2-speed switch.
- Models 150TSW and 200TSW include a 1-30 minute adjustable run-on timer and external mounted 2-speed switch.
- Fans can be removed for maintenance or repair without disturbing the duct system via specially designed support brackets.
- Integrated mounting foot makes installation easier.
- All models include plug and lead for easy installation.
- Can be mounted in any position.

Construction

The housings are of reinforced, injection moulded polypropylene plastic.

The mixed-flow impellers are of injection moulded plastic.

Motors

Type - 2-speed, squirrel cage, capacitor run.

Electricity supply - 230V, single-phase, 50Hz.

Class B insulation, IP44.

Bearings - sleeve for RIL-100 and RIL-125, ball for all other models.

Speed-controllable using VA type speed controller in high speed setting only.

The RIL-150TSW and RIL-200TSW cannot be speed controlled.

See pages O-3/4 for details on the motors.

Internal Thermal Protection

By fuse to size 125 and for all other models manual-reset thermal overload protection device in accordance with mandatory requirement for in-duct fans AS/NZS60335-2-80:2004







Testing

Air flow to ISO5801:Part1, 1997

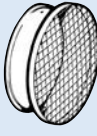
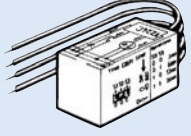
Noise to BS848:Part 2, 1985

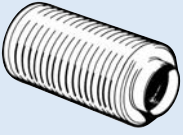
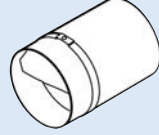
Meets requirements of AS/NZS60335-2-80:2004

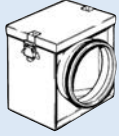
ANCILLARY EQUIPMENT

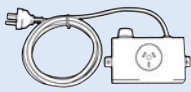
| | | |
|---|--|--|
|  MRJ - Inlet grille Ref. J-9 |  VZ - Run-on timer [†] Ref. M-14 |  TSS1 - 2-Speed switch [†] Ref. B-17 |
|  CC - Attenuators Ref. H-16 |  SJK - Backdraft Damper Ref. J-3 |  RSK - Backdraft Dampers Ref. J-3 |
|  FC - Fast clamp Ref. J-5 |  FGR - Filter Unit Ref. J-10 |  VA - Speed controller [†] Ref. M-5 |
|  Plug-In Run-on Timer and Speed Controller [†] Ref. M-16 | | |

[†] Not suitable for models RIL-150TSW and RIL-200TSW which have integral Run-on Timers.

Special Notes

Timer models RIL-150TSW and RIL-200TSW include a plug and lead to suit HPM 4 pin socket.

Avoid the use of spring-loaded backdraft dampers, extensive lengths of duct and air valves with the RIL-100 and RIL-125 models.

TECHNICAL DATA

| Model Number | Fan Speed rev/sec | Avg. dB(A) @ 3m | RIL.. 1 ph Watts | App. Amps | Max. amb °C | App. wt. kg |
|--------------|-------------------|-----------------|------------------|-------------|-------------|-------------|
| RIL-100 | 37 / 31 | 36 / 32 | 24 / 18 | 0.11 / 0.10 | 40 | 2.0 |
| RIL-125 | 38 / 32 | 37 / 39 | 30 / 22 | 0.13 / 0.10 | 40 | 2.0 |
| 150SW | 42 / 33 | 45 / 38 | 50 / 44 | 0.22 / 0.19 | 60 | 2.7 |
| 150TSW | 42 / 33 | 45 / 38 | 50 / 44 | 0.22 / 0.19 | 60 | 2.7 |
| 200SW | 42 / 33 | 51 / 44 | 120 / 100 | 0.50 / 0.45 | 60 | 4.9 |
| 200TSW | 42 / 33 | 51 / 44 | 120 / 100 | 0.50 / 0.45 | 60 | 4.9 |

Values shown are High Speed / Low Speed

HOW TO ORDER

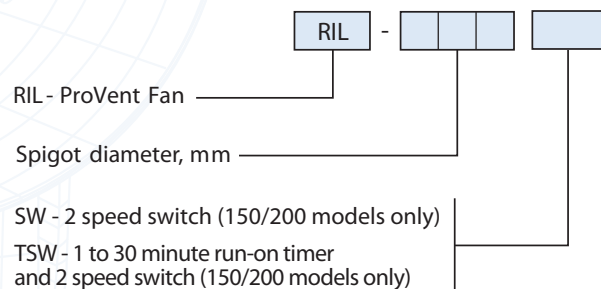

Scan the QR Code to view more information online.



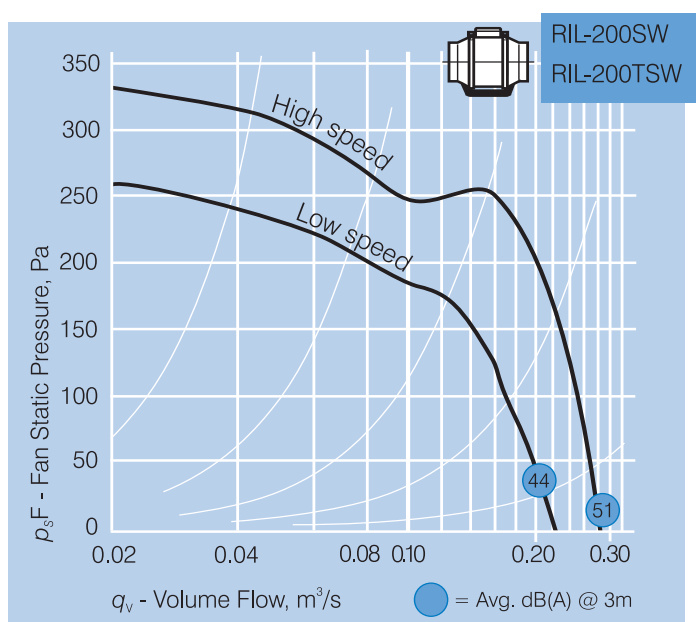
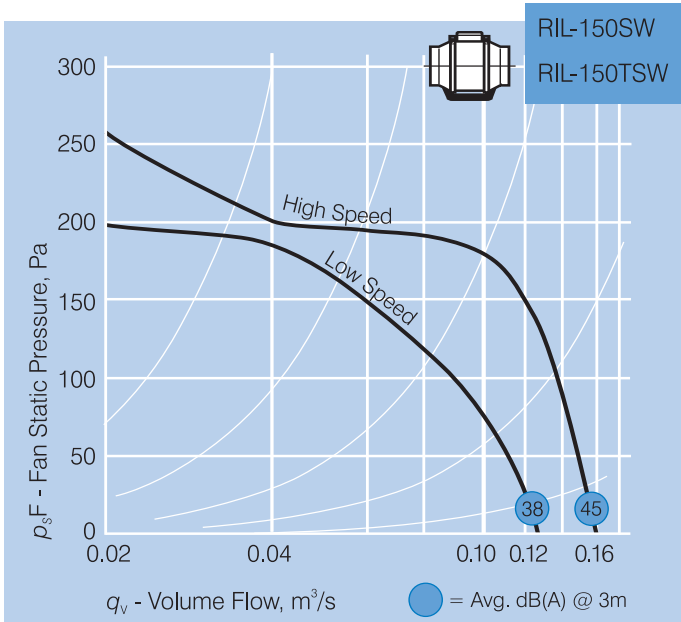
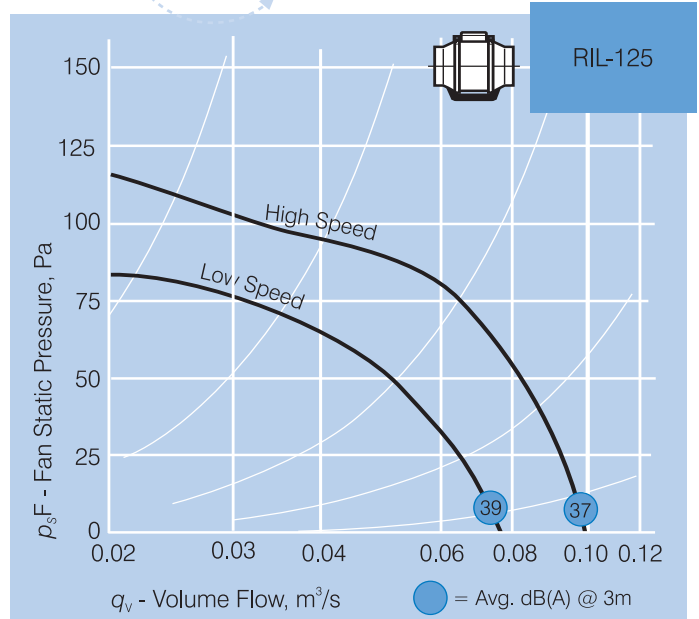
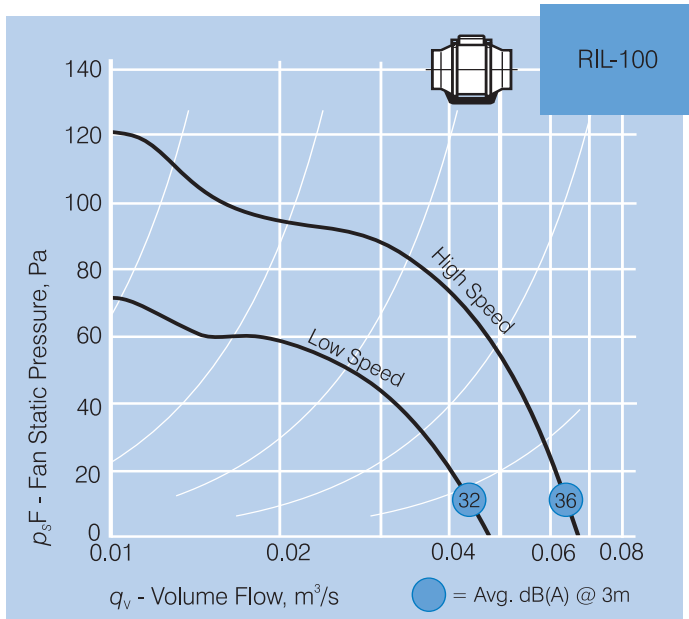

NOISE DATA

| Model Number | Avg. dB(A) @ 3m | In-duct Sound Power Levels L_w dB re 1pW | | | | | | | |
|--------------|-----------------|--|-----|-----|-----|----|----|----|----|
| | | 63 | 125 | 250 | 500 | 1k | 2k | 4k | 8k |
| RIL-100 | 36 | 54 | 63 | 55 | 56 | 52 | 48 | 40 | 32 |
| RIL-125 | 37 | 61 | 63 | 55 | 56 | 54 | 51 | 42 | 32 |
| RIL-150 | 45 | 58 | 51 | 64 | 60 | 59 | 63 | 57 | 47 |
| RIL-200 | 51 | 63 | 63 | 70 | 66 | 68 | 68 | 65 | 53 |

Sound Power Levels shown are based on the high speed inlet side for each fan.

SUGGESTED SPECIFICATIONS

The in-line fans shall be of the ProVent Series as supplied by Fantech Pty Ltd and be of the model numbers shown on the schedule/drawings.

Impellers shall be of mixed-flow design and driven by a single-phase motor. Internal thermal protection shall be by fuse on 100 and 125mm spigot models and by manual-reset on 150 and 200mm models.

It shall include an integral mounting foot, plug and lead and specially designed support brackets to enable motor removal. All fans shall be fully tested to ISO5801: Part1, 1997 for air flow and BS848:Part 2, 1985 for noise.

DIMENSIONS

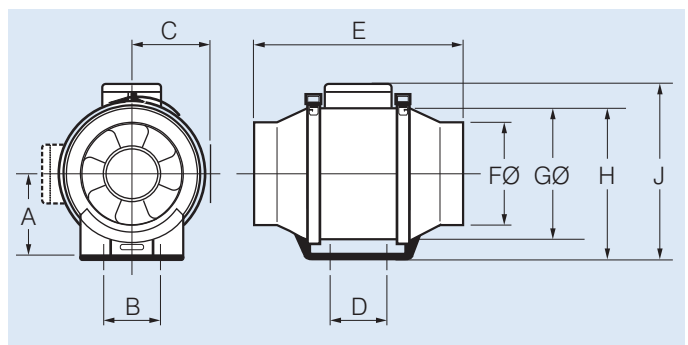

| Model Number | Dimensions, mm | | | | | | | | | |
|--------------|----------------|----|-----|-----|-----|-----|-----|-----|-----|--|
| | A | B | C | D | E | FØ | GØ | H | J | |
| RIL-100 | 100 | 60 | 115 | 80 | 303 | 97 | 176 | 190 | 220 | |
| RIL-125 | 100 | 60 | 115 | 80 | 258 | 123 | 176 | 190 | 210 | |
| RIL-150 | 112 | 60 | 127 | 80 | 295 | 147 | 200 | 225 | 236 | |
| RIL-200 | 124 | 94 | 141 | 100 | 302 | 198 | 217 | 235 | 265 | |